

IL MULTIVERSO FILOMURO

GAROFOLI
GROUP

INDICE

4_ IL MULTIVERSO FILOMURO	LA SCELTA DEL TELAIO pag. 6 LA SCELTA DEL L'ANTA pag. 8
10_ SOLUZIONI TRADIZIONALI	FILOMURO 45 MM pag. 12 FILOMURO 60 MM pag. 14 FILOMURO 103 MM pag. 16 FILOMURO DOPPIA pag. 18
20 SOLUZIONI INNOVATIVE	FILOMURO BIVERSO pag. 22 FILOMURO BILATO pag. 26 FILOMURO BILICO pag. 30 FILOMURO BOISE pag. 34 FILOMURO BIPLAN pag. 38 FILOMURO PANVI pag. 40 FILOMURO BIGLASS pag. 42 FILOMURO BIGLASS A SPECCHIO pag. 46 TOTAL BIGLASS pag. 48 FILOMURO RUBIA pag. 50 FILOMURO G-LIKE PROFILO MINIA 1 V pag. 54 FILOMURO G-LIKE PROFILO BLADE pag. 58 1TV POMPA PIVOTANTE pag. 60 1TV TELAIO 45 E 103 pag. 62
64_ FILOMURO REI	FILOMURO REI 30 pag. 66 FILOMURO REI 60 pag. 68 FILOMURO REI 120 pag. 72
74_ FILOMURO BLINDATA	FILOMURO REGINA pag. 76
78_ SOLUZIONI COMPLEMENTARI	ARMADI FILOMURO MIRIA pag. 80 BATTISCOPIA FILOMURO pag. 84 CHIUDI CHIUDI FILOMURO pag. 86
88_ FINITURE FILOMURO	
92_ TIPOLOGIE DI MANIGLIE	
98_ ACCESSORI	
104_ SPECIFICHE TECNICHE	
116_ SEZIONI	

IL MULTIVERSO FILOMURO

THE FILOMURO MULTIVERSE

Porta blindata Filomuro Regina
Filomuro Regina security door

Chiudi-Chiudi tinteggiabile
Paintable Chiudi-Chiudi

Filomuro tinteggiabile
Paintable Filomuro

Esempi di
Chiudi-Chiudi
tinteggiabile
*Examples of
Paintable
Chiudi-Chiudi*

Porta a battente
Filomuro doppia
*Double Filomuro
hinged door*

Miria a battente doppia,
versione Filomuro
*Miria double hinged door,
Filomuro version*

Porta a battente Filomuro a tutta
altezza (senza traversa superiore)
*Full height Filomuro hinged door (no
upper lintel)*

Porta Filomuro a battente con
sopraluce ad anta fissa
*Filomuro hinged door with fixed
transom*

Porta a battente Filomuro
singola o a bilico o bilato
o biverso o Rei 30-60-120
*Filomuro hinged door: single,
pivot, Bilato, Biverso or
Rei 30-60-120*



IL MULTIVERSO FILOMURO

THE FILOMURO MULTIVERSE

LA PORTA FILOMURO: quando, come e perchè

THE FILOMURO DOOR: Where, how and why

La scelta di una porta Filomuro può essere dettata da diverse esigenze: **mantenere inalterata** l'estetica minimale di uno spazio; rendere meno visibili passaggi ad ambienti secondari, come dispense oppure ripostigli; permettere **decorazioni particolari** su superfici ampie (includendo l'elemento "porta"), utilizzare **sistemi di apertura innovativi**. Per offrirti il massimo della scelta Filomuro, la nostra collezione di porte raso parete, è adattabile alla maggior parte dei modelli delle collezioni, anche nelle versioni più particolari: scorrevole, battente a due ante fino ad arrivare alla porta inclinata per sottotetti. Ciò vuol dire che **il TELAIO deve essere pensato già in una fase di progettazione architettonica** dell'intervento, in quanto dovrà essere **murato prima di procedere con le finiture**. La scelta dell'**ANTA invece potrà essere fatta anche in un secondo momento**, in modo da poterla coordinare agli altri prodotti Garofoli e allo stile degli arredi che saranno scelti per l'interno.

*A Filomuro door can be your solution for any number of needs: **maintaining the minimal aesthetics** of a space; concealing passages to secondary spaces such as storage rooms or closets; allowing **special decorations** on large surfaces (including the door elements), or for utilisation of **innovative opening systems**. To offer you the widest variety of options, the Filomuro collection of flush-mounted doors can be adapted to most of the styles of the Garofoli collections, including the most unusual versions: sliding doors, hinged double doors, even angled doors made to fit under sloping ceilings. Given that **the FRAME has to be walled in before proceeding with the interior finishes**, this means that it **must be planned at an early stage of the architectural design**. The choice of **the DOOR, on the other hand, can be made later on**, to coordinate with other Garofoli products and any style of interior furnishings you choose.*

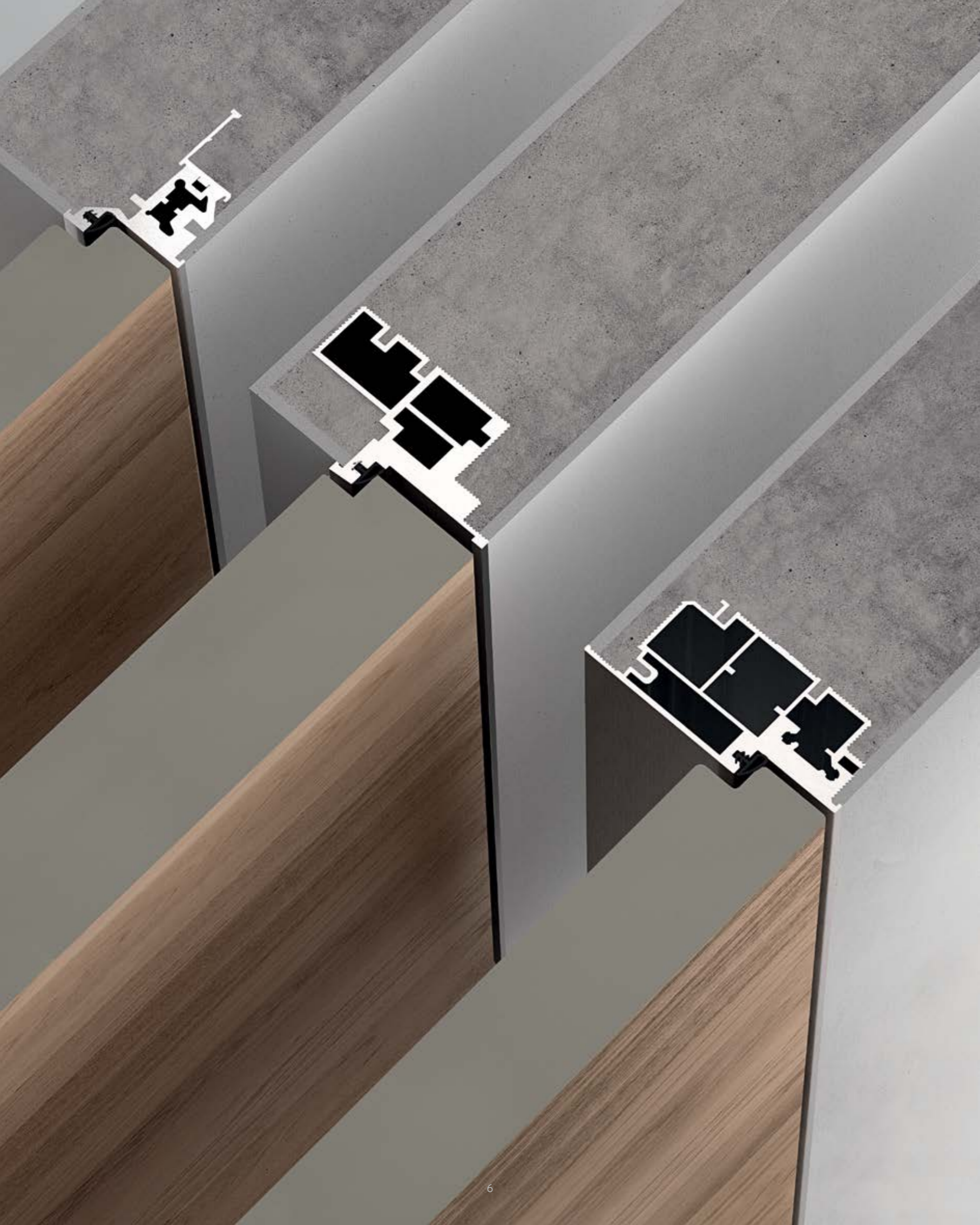

LA SCELTA DEL TELAIO

CHOOSING THE FRAME

Innanzitutto occorre scegliere il tipo di telaio che deve essere installato **già in fase di costruzione**. La scelta del telaio si basa sull'analisi di esigenze funzionali come la scelta dell'apertura ed estetiche, quali la continuità con altri elementi d'arredo. Che si tratti di nuovi progetti architettonici o di ristrutturazioni, Garofoli propone una gamma esclusiva di telai, ideali per qualsiasi tipo di porta. Di assoluta qualità strutturale, i telai firmati Garofoli sono il frutto di una grande esperienza, di **ricerca e innovazione costanti**, per questo assicurano le più elevate performance tecniche. Oltre al sistema tradizionale che prevede la muratura, i telai possono essere montati direttamente su cartongesso. Estremamente **compatti e resistenti**, i telai Garofoli possono essere **personalizzati** con verniciatura bianca, nera o ral.

*The first choice to be made, in preparation for **installation during the construction phase**, is the type of frame. This depends on an analysis of your functional needs, such as the kind of opening necessary, and aesthetic continuity with other furnishings. Garofoli offers an exclusive range of frames, ideal for any type of door in both renovation and new building contexts. The quality is uncompromising, based on our extensive experience and **constant research and innovation**, and guarantees the highest standards of technical performance. The frames can be mounted in both traditional masonry and plasterboard systems. Garofoli frames **are extremely solid and resistant**, and they **can be customised** at our factory with white, black or RAL paints.*



LA SCELTA DELL' ANTA

CHOOSING THE DOOR

E' davvero **infinita la gamma** di soluzioni, dimensioni e materiali per una scelta esclusiva d'intramontabile **stile e qualità**. In legno, laccate lucide o opache, tinteggiabili, a una o due ante, in vetro, a soffitto, a battente, blindata e antincendio, di tutte le dimensioni e i colori. Non resta che scegliere la porta su misura per il proprio **stile abitativo**.

*The range of solutions, **sizes and materials is truly infinite**, meaning that your choice will be exclusive and timeless in **style and quality**. Options range from glossy or matt pre-lacquered wood to paintable and glass finishes, with single or double doors, hinged door, ceiling height, in security construction or fireproof, and of all sizes and colours. All that's left is to choose **the door that's right for you**.*



**SOLUZIONI
TRADIZIONALI**
TRADITIONAL SOLUTIONS



Finitura Rovere Decapè
Pickled Oak finish

FILOMURO 45 MM

TELAIO 45 MM

FILOMURO 45 MM - FRAME 45 MM

Contemporanea ed essenziale, la dimensione di 45 mm esprime la leggerezza di una soluzione elegante e discreta. Le linee **pulite e lo spessore minimo** la rendono ideale per diversi contesti abitativi. Può essere installata ovunque, su muratura e cartongesso, è disponibile a spingere e a tirare e, grazie alla **grande varietà di ante disponibili**, rappresenta la sintesi ideale di stile e funzionalità.

MURATURA - MASONRY
TIPO T - TYPE T



Contemporary and essential, the 45 mm dimension creates a light, elegant and discrete solution. The **clean lines and minimal thickness** make it ideal for different residential contexts. This dimension can be installed anywhere, in masonry and plasterboard walls, is available in push and pull formats, and **thanks to the wide variety of doors available**, represents an ideal synthesis of style and functionality.



Finitura tinteggiabile cemento
cement paintable finish

FILOMURO 60 MM

TELAIO 60 MM

FILOMURO 60 MM - FRAME 60 MM

Nello spessore di 60 mm, con cerniere ad alta portata SIMONSWERK (riconosciuta tra le migliori al mondo), in tutte le finiture Garofoli. L'opzione della Filomuro in spessore 60 mm consente di avere una **maggiore insonorizzazione** e la possibilità di aggiungere **accessori supplementari**, come la slitta per la chiusura automatica nascosta -incassata- e la guarnizione per la certificazione Rei.

MURATURA - MASONRY
TIPO T - TYPE T



*The version with a 60 mm thickness comes with SIMONSWERK high load capacity hinges – among the best in the world – in all Garofoli finishes. The 60mm Filomuro option allows you to **increase acoustic insulation** and includes **additional accessories**, such as the slide for hidden – recessed – automatic closure and the gasket for the Rei certification.*



Finitura Rovere Creta
Clay Oak finish

FILOMURO 103 MM

TELAIO 103 MM

FILOMURO 103 MM - FRAME 103 MM

Realizzata per pareti in cartongesso e muratura, è **particolarmente agevole da installare**. Il telaio da 103 mm copre l'intero spessore della muratura ed è disponibile sia nella versione a spingere sia a tirare.

MURATURA - MASONRY
TIPO T - TYPE T



The 103-mm frame, made for plasterboard and masonry walls, is **particularly easy to install**. The frame covers the entire thickness of the masonry. Available in push and pull versions.



Finitura tinteggiabile
Paintable finish

FILOMURO DOPPIA

FILOMURO DOUBLE

Molte delle porte della collezione Filomuro sono disponibili nella versione doppia e sono personalizzabili in diversi formati e materiali. Nelle **linee essenziali** della contemporaneità o nell'intramontabile eleganza del legno massello, una porta Filomuro si adatta perfettamente a ogni ambiente, trasformando un'esigenza funzionale in elemento d'arredo, perfettamente lineare perché priva di parti in rilievo, come cerniere e cornici.

TELAIO 103 - FRAME 103
MURATURA - MASONRY
TIPO T - TYPE T



*Many of the doors in the Filomuro collection are available in a double version, which can be customised in various formats and materials. In either the **essential lines** of contemporary styles or the timeless elegance of solid wood, a Filomuro door adapts perfectly to any environment, transforming a functional need into a furnishing element. The installation is always completely linear, without protruding elements such as hinges or frames.*



**SOLUZIONI
INNOVATIVE**

INNOVATIVE SOLUTIONS



Finitura Rovere Ice
Ice Oak finish

FILOMURO BIVERSO

FILOMURO BIVERSO

Un nuovo sistema di apertura brevettato. Particolarità della Biverso sono **cerniere a bilico** e **reversibilità**: la porta è installabile e apribile indifferentemente a tirare o a spingere. Il telaio della nuova porta Biverso è universale: può essere installato sia su pareti in cartongesso sia in muratura e posizionato **in qualsiasi punto all'interno del vano muro**.

La doppia guarnizione e la serratura magnetica trattengono la porta in battuta.

*A new patented opening system. Features of the Biverso: **pivot hinges**; reversible (the door can be installed and opened both ways, push or pull). The frame for the new Biverso door is universal: it can be installed both on plasterboard or masonry walls and can be positioned **at any point inside the wall recess**.*

The double seal and the magnetic lock hold the door in place.

MURATURA - MASONRY







Finitura lato esterno tinteggiabile, effetto cemento; finitura lato interno rivestita interamente con boiserie in Rovere Decapè
external finish cement plaster; interior finish cover of boiserie Pickled Oak finishing

FILOMURO BILATO

FILOMURO BILATO

La versione Bilato della collezione Filomuro è una porta a battente con cerniere a scomparsa, l'anta di spessore 103 mm conferisce **complanarità al muro su entrambi i lati**. La Filomuro Bilato può essere installata sia su pareti in muratura sia in cartongesso ed è disponibile nelle finiture tinteggiabili, laccata bianca, laccata RAL, in legno nelle diverse essenze di rovere.

MURATURA - MASONRY



The Bilato version of the Filomuro collection is a 103-mm-thick door with concealed hinge, **completely flush with the wall on both sides**. Filomuro Bilato can be installed in both masonry and plasterboard walls and is available in white lacquer, RAL lacquer and in the different finishes of oak wood.



Finitura lato esterno tinteggiabile, effetto cemento; finitura lato interno rivestita interamente con boiserie in Rovere Decapè
external finish cement plaster; interior finish cover of boiserie Pickled Oak finishing



Finitura tinteggiabile, effetto cemento
cement plaster finish

FILOMURO BILICO

FILOMURO BILICO

Esclusiva e raffinata la scelta di una versione in grado di **ruotare su se stessa**, fino a 90°, grazie al fissaggio di un perno sulla staffa. La porta a bilico consente di **ottimizzare gli spazi** assicurando la massima complanarità su entrambi i lati, estrema funzionalità e facilità di passaggio da un ambiente all'altro.

MURATURA - MASONRY



*Exclusive and refined: a door that rotates around its axis, thanks to the insertion of a pin and pivot. Filomuro Bilico is completely flush on both sides, yet swings open up to a full 90°, thus **optimising spaces** with extreme functionality and ease of passage from one environment to another.*



Finitura Rovere Tabacco
Tobacco Oak finish



Finitura pannelli boiserie Laminato
Boiserie laminate panel finish

FILOMURO BOISE

TELAIO BOISE

FILOMURO BOISE - BOISE FRAME

La filomuro Garofoli si veste di boiserie. Questa soluzione è studiata per applicazioni che consentono la perfetta continuità materica tra l'anta e la parete che l'accoglie. La continuità visiva è garantita dal particolare telaio che permette l'alloggiamento complanare dei pannelli della porta con quelli della boiserie. Le finiture possibili sono ampie e comprendono i legni delle boiserie Garofoli e i laminati Gidea. Sul piano architettonico questa proposta permette di realizzare pareti continue dove la porta è parte integrante di un sistema visivo articolato.

MURATURA - MASONRY



boiserie
boiserie

Garofoli presents the wall dressed in boiserie. This solution is designed for applications with a perfect continuity of material between the door and the wall that houses it. Thanks to a specifically designed frame, the door panels remain completely flush with those of the surrounding wall, obtaining perfect visual continuity. The wide range of finishes includes Garofoli wood panelling and Gidea laminates. Filomuro Boise allows the design of continuous walls, with the door becoming of an integral part of the overall visual system.



Finitura pannelli boiserie Rovere Ice
boiserie Ice oak panel finish



Finitura rovere teak
teak oak finish

FILOMURO BIPLAN

FILOMURO BIPLAN

Interamente strutturata in alluminio, lo spessore della Biplan è di 45 mm. Il profilo è tamponato da due superfici dello spessore di 5 mm. Biplan consente la personalizzazione dei pannelli delle ante con i legni Garofoli, anche differenti sui due lati, rendendo questo prodotto ideale nella realizzazioni di ambienti in cui si desidera accentuare la discontinuità degli spazi.

Biplan is a 45 mm-thick door completely framed in aluminium, providing for insertion of two 5 mm surfaces. This system allows customisation using Garofoli wood panels, which can be different on either side: ideal for accentuating discontinuity of spaces in the design of the overall environment.

MURATURA - MASONRY
ESEMPIO TIPO S - EXAMPLE TYPE S

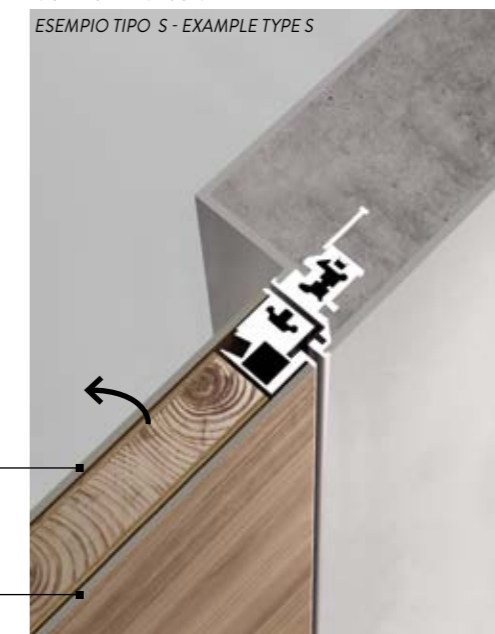

pannello in legno / laccato
panel in wood / lacquered finish

pannello in legno / laccato
panel in wood / lacquered finish



Vedi catalogo Bisystem
di Garofoli per approfondimenti
See Garofoli Bisystem catalogue
for details



Finitura lato vetro color corda
glass finish, hemp colour

FILOMURO PANVI

FILOMURO PANVI

Lo spessore della Panvi è di 4,5 cm, interamente strutturata in alluminio. Il profilo è tamponato da due superfici dello spessore di 5 mm. I pannelli di rivestimento della porta sono vetro su di un lato e legno sull'altro. I vetri sono coprenti o a specchio. Questa soluzione è ideale per ambienti come il bagno o la camera da letto, dove è possibile trasformare la porta in una vera e propria specchiera.

Panvi is a 4.5-cm-thick door completely framed in aluminium, providing for insertion of two 5 mm thick cladding panels. The surfaces are wood on one side and glass on the other, and the glass can be opaque or mirrored. This solution is ideal for environments such as the bathroom or bedroom, where the door can become a mirror.

MURATURA - MASONRY
ESEMPIO TIPO S - EXAMPLE TYPE S

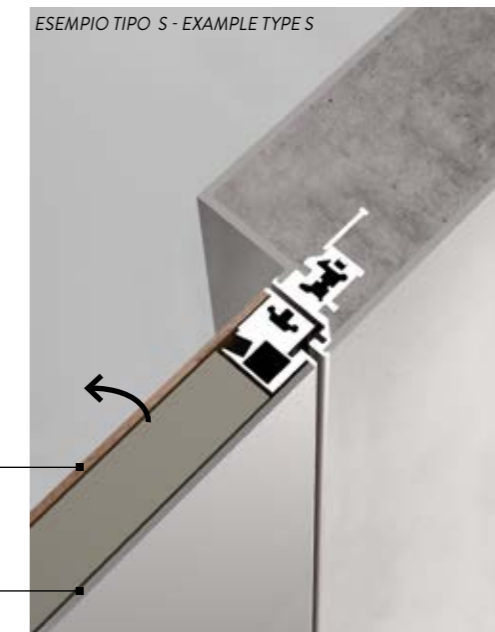

pannello in legno / laccato
panel in wood / lacquered finish

specchio / vetro
mirror/glass



Finitura vetro fumè trasparente
transparent smoked glass finish

FILOMURO BIGLASS

FILOMURO BIGLASS

In equilibrio tra privacy e trasparenza sono disponibili diverse tipologie di porte: con sezioni in vetro e profilo in alluminio. Una porta filomuro in vetro elegante e resistente diventa elemento estetico e concettuale, separa ma non divide gli spazi, esalta la profondità dell'ambiente. Può essere personalizzata nelle finiture, con bordo in alluminio, inox o nei colori RAL ed è realizzata a una o due ante, nella versione scorrevole interno o esterno muro.

MURATURA - MASONRY
ESEMPIO TIPO T - EXAMPLE TYPE T

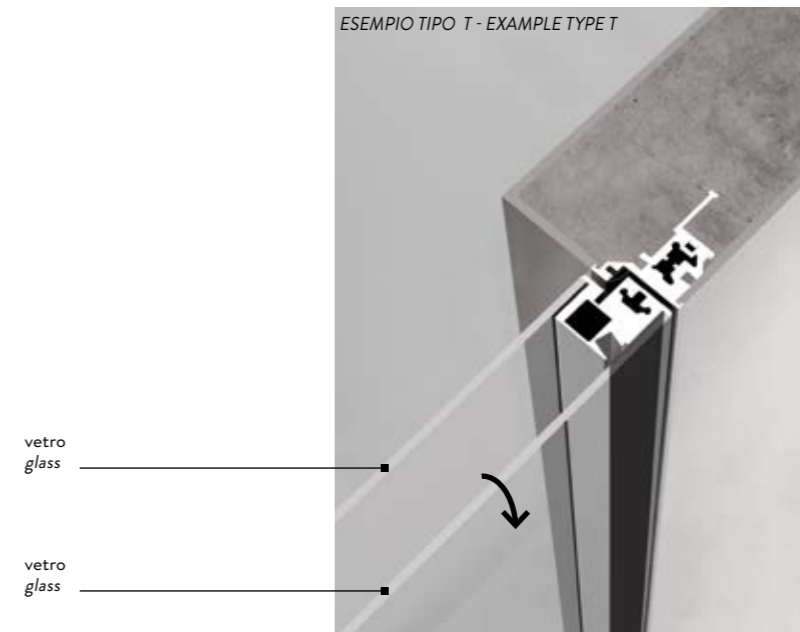

The Filomuro collection includes a range of aluminium profiles for mounting glass, achieving different types of doors that create a **balance between transparency and privacy**. An elegant and resistant flush glass door becomes an aesthetic and conceptual element. It separates the spaces without dividing them and enhances the depth of the environment. The profile finish can be customised, with aluminium or stainless steel edges or in the RAL colours. Biglass can also be produced in pocket or external sliding versions, with single or double doors.



Finitura vetro fumè trasparente
transparent smoked glass finish



Finitura specchio
mirror finish

FILOMURO BIGLASS A SPECCHIO

FILOMURO BIGLASS MIRROR

La versione Biglass a Specchio caratterizza l'ambiente nel segno di una raffinata eleganza. **Specchi super riflettenti** esaltano tutte le potenzialità estetiche del vetro, sono riflessi e trasparenze incorniciate con stile, perfettamente planari e sicure. La versione specchiante può essere portata su **uno o entrambi i lati**.

MURATURA - MASONRY
ESEMPIO TIPO S - EXAMPLE TYPE S

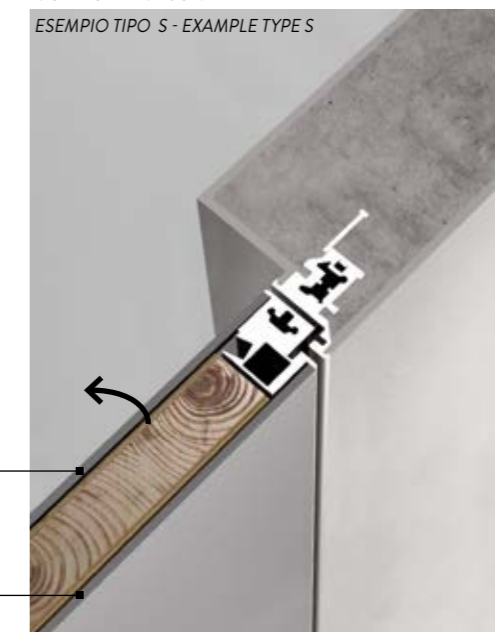

vetro laccato / specchio
lacquered glass/mirror

vetro laccato / specchio
lacquered glass/mirror

*The Biglass Mirror version instils a refined elegance in the environment. Stylish frames, designed for hinged or pocket doors, set off reflections or transparencies. **Super reflective mirrors**, installed on **one or both sides**, bring out all the aesthetic potential of glass, while the structures remain perfectly flat and safe.*



Finitura vetro trasparente
transparent glass finish

TOTAL BIGLASS

TOTAL BIGLASS

La Total Biglass è un'anta vetrata con **cerniera a bilico decentrata, che ne permette l'apertura da entrambi i lati**. Il telaio della porta è affogato su pareti e soffitto, complanare alle superfici d'installazione: progettato per non essere visibile a porta chiusa, il telaio può essere personalizzato nelle finiture Ral, magari in tinta con le pareti, garantendo l'effetto estetico di **continuità** anche ad anta aperta. Total Biglass può essere realizzata in grandi dimensioni, fino a 1400 mm di larghezza e fino a 3000 mm di altezza.

MURATURA - MASONRY

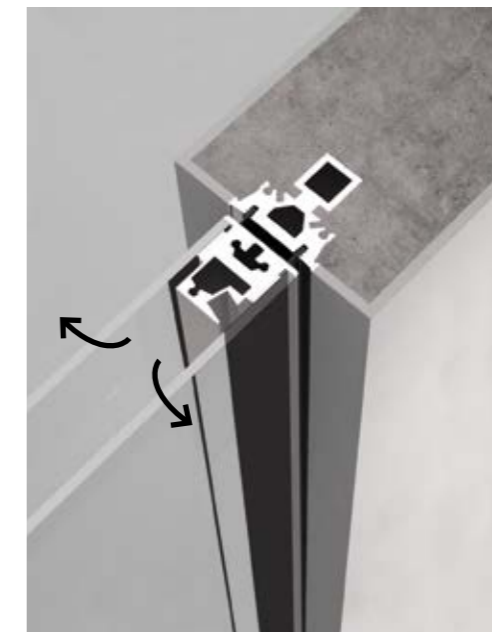

*Total Biglass is a glass door leaf with **decentered pivot hinge, allowing it to be opened by pulling or pushing**. The door frame is sunk into the wall and ceiling, flush with the installation surfaces: designed not to be visible once the door is closed, the frame Ral color is customizable, maybe to match the walls tint, for beautifully **seamless results**, even with the door open. Total Biglass can be made in large sizes, up to 1400 mm in width and 3000 mm in height.*



Finitura vetro trasparente riflettente tipologia S (a spingere)
Finish in reflective transparent glass. Type S (push)

FILOMURO RUBIA

FILOMURO RUBIA

Il vetro è ancora protagonista dello spazio, creando continuità tra ambienti diversi, ne esalta le caratteristiche stilistiche. Disponibile in diverse misure e soluzioni, Rubia connota l'ambiente nel segno di una delicata, **trasparente luminosità**.

Il telaio dell'anta, in alluminio, presenta un profilo dal design essenziale e minimalista perfettamente complanare sul lato a tirare.

Rubia è una filomuro in alluminio e vetro che permette ampie personalizzazioni nella scelta dei colori in abbinamento. Inox, bianco, nero e qualsiasi colore RAL per il telaio e per i vetri Garofoli per il completamento dell'anta. Ideale per soluzioni architettoniche contemporanee.

*With Filomuro Rubia, glass is the protagonist of the space, creating continuity between different environments and enhancing the features of their style. Available in different sizes and solutions, this system characterizes the environment in the sign of a delicate, **transparent brightness**.*

The aluminium frames, with flush fit on the pull side, offer essential and minimalist profiles.

Rubia is a Filomuro door in aluminium and glass that offers exceptional customisation through the choice of matching colours: stainless steel finish, white, black or any RAL colour for the frame, and selection from the range of Garofoli glass for completion. Ideal for contemporary architectural solutions.

TELAIO 103 - FRAME 103
MURATURA - MASONRY
TIPO T - TYPE T





**FILOMURO
RUBIA PROJECT**

TIPS
HANDMADE LIVING
DO
HOFMANN

Finitura vetro trasparente riflettente
transparent reflective glass finish



Finitura vetro trasparente
transparent glass finish

FILOMURO G-LIKE

PROFILO MINIA 1V

FILOMURO G-LIKE - MINIA 1V PROFILE

G-LIKE accende l'ambiente di soffusa eleganza. Contemporanea ed essenziale può essere installata raso muro o con un telaio in alluminio contemporaneo, G-LIKE si declina in **molteplici modelli e finiture e con due tipologie di profili, G-LIKE e BLADE** per una soluzione su misura perfetta in ogni dettaglio.

*G-LIKE lights up the room with soft elegance. G-LIKE doors are available in many models and finishes, with two types of edge profiles: **BLADE and MINIA IV**, for either a flush fit against the frame or a thin profile effect. Always contemporary and essential, these choices allow tailor-made solutions that are perfect in every detail. Ideal for contemporary design environments.*

G-LIKE MINIA IV - MURATURA
G-LIKE MINIA IV - MASONRY



Vedi catalogo G-Like
di Garofoli per approfondimenti
See Garofoli G-Like catalogue
for details



Sulla sinistra: Finitura vetro Madras. Sulla destra: Finitura vetro trasparente
Left: Finish in Madras glass. Right: Finish in transparent glass.



Finitura vetro serigrafato strip double face con base trasparente
 Strip double-sided screen-printed glass finish with a transparent base

FILOMURO G-LIKE

PROFILO BLADE

FILOMURO G-LIKE - BLADE PROFILE

Blade è una filomuro in vetro strutturata in alluminio, il quale è declinabile nelle varie finiture inox, bianco, nero e ral a scelta. Il profilo dell'anta è stato concepito per poter accogliere un pannello di tamponamento in vetro, laminato o in laminato ceramico complanare al muro nel lato a tirare. Questa soluzione è ideale per ambienti contemporanei e di stile.

MURATURA - MASONRY



Blade is a glass flush door framed in aluminium, available in a choice of finishes ranging from stainless steel to white, black and all the RAL colours. The door profile is designed to hold a glass, laminate or ceramic laminate panel, with a flush fit on the pull side. This solution is ideal for stylish, contemporary environments.



Vedi catalogo G-Like di Garofoli per approfondimenti
 See Garofoli G-Like catalogue for details



Finitura vetro flute
Flute glass finish

1TV

CON CERNIERA PIVOTANTE
1TV WITH PIVOTING HINGE

Questa filomuro in vetro complanare nel lato a tirare ha la caratteristica unica di non avere un telaio integrato nel muro.
Due cerniere portanti svolgono anche la funzione strutturale. Questa soluzione è ideale nelle realizzazioni che presentano varchi preesistenti in cui non si vuole intervenire sulla muratura.

MURATURA - MASONRY
TIPO T - TYPE T

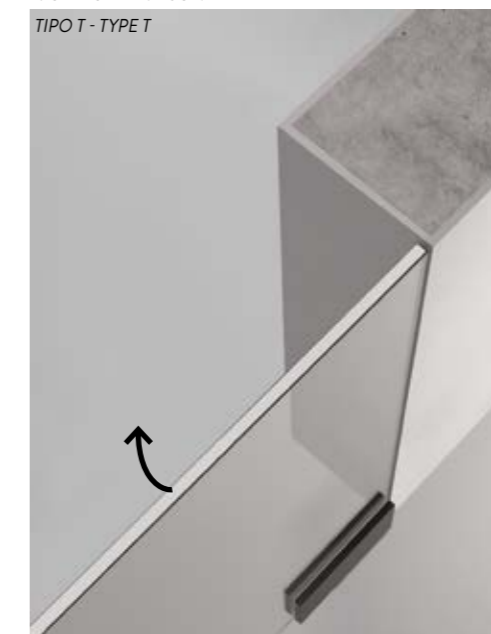

This door, flush in the pull side, has the unique feature of not requiring a frame: the structural function is instead performed by two load-bearing hinges. This solution is ideal when the design objective is to use an existing opening without intervening on the masonry.



Vedi catalogo Emozioni di Vetro di Garofoli per approfondimenti
See Garofoli Glass Emotions catalogue for details



Finitura vetro trasparente
transparent glass finish

1TV

TELAIO 45 e 103

1TV FRAME 45 and 103

La 1 Tv presenta un telaio minimale incassato nel muro. L'anta si presenta come un grande pannello di vetro. Due cerniere a vista completano l'oggetto donandogli forza e carattere. Ampie sono le possibilità di configurazione dei vetri, declinabili nell'abaco offerto dal catalogo emozioni in vetro di Garofoli.

The 1TV features a minimal, wall-recessed frame. The door consists of a large glass panel with two visible hinges, giving a sense of character and strength. The glass is available in wide range of configurations, as seen in the Garofoli Glass Emotions catalogue. Frame and hinges in finishes of stainless steel, black, white or RAL lacquers.

TELAIO 45 - FRAME 45
MURATURA - MASONRY
TIPO T - TYPE T



Vedi catalogo Emozioni di Vetro di Garofoli per approfondimenti
See Garofoli Glass Emotions catalogue for details



FILOMURO REI

Garofoli propone una collezione esclusiva di **porte tagliafuoco**, per la protezione e la sicurezza di ambienti pubblici e privati, nel pieno rispetto delle più severe **normative internazionali**. Solide e sicure le porte Rei sono disponibili in un'ampia gamma di soluzioni e finiture.

*Garofoli offers an exclusive collection of **fire doors**, for the safety and protection of public and private environments in full compliance with the strictest **international standards**. Solid and secure, Rei doors are available in a wide range of solutions and finishes.*



Finitura tinteggiabile cemento
cement plaster finish

FILOMURO REI 30

FILOMURO REI 30

Porta resistente al fuoco con telaio in alluminio estruso da inserire nella muratura o nel cartongesso compreso di **guarnizioni per rumore e fumi freddi**. Spessore da mm. 45 con resistenza al fuoco EI 30. Anta spessore 45 mm complanare al muro sul lato a spingere o tirare. Guarnizioni intumescenti sul telaio.

FONO ISOLAMENTO 35-38-40 db

*Fire resistant door with extruded aluminum frame to fit in the masonry or in plasterboard, which includes **seals for noise and cold fumes**. 45 mm thick for EI 30 fire resistance. 45 mm thick leaf which can be flush to the wall in the pull or push side. Intumescent gasket on the frame.*
SOUND INSULATION 35-38-40 db

MURATURA - MASONRY
TIPO T-TYPE T



Vedi catalogo Rei di Garofoli
per approfondimenti
See Garofoli Rei catalogue
for details



Finitura laccata nera lucida
black gloss lacquer finish

FILOMURO REI 60

FILOMURO REI 60

Porta resistente al fuoco con telaio in alluminio estruso da inserire nella muratura o nel cartongesso con spessore almeno da 125 mm, per avere resistenza al fuoco EI 60. Anta spessore 60 mm, **complanare al muro sul lato a spingere o tirare**. Guarnizioni intumescenti sul telaio.

FONO ISOLAMENTO 28-38-42 db

*Fire resistant door with extruded aluminum frame to fit in the masonry or in plasterboard 125 mm thick to be sure of EI 60 fire resistance. 60 mm leaf which **can be flush to the wall on pull or push side**. Intumescent gasket on the frame.*
SOUND INSULATION 28-38-42 db.

MURATURA - MASONRY
TIPO S - TYPE S

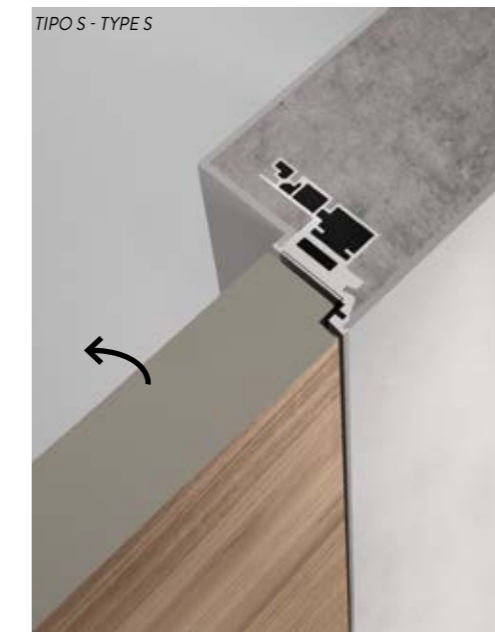

Vedi catalogo Rei di Garofoli
per approfondimenti
See Garofoli Rei catalogue
for details



Finitura laccata RAL 5011 opaca
RAL 5011 matt lacquer finish



→
EXIT

Finitura intonacata cemento
cement plaster finish

FILOMURO REI 120

FILOMURO REI 120

Porta resistente al fuoco con telaio alluminio estruso da inserire nella muratura o nel cartongesso con spessore almeno da 125 mm, per avere resistenza al fuoco EI 120. Anta spessore 103 mm, complanare al muro sul lato a spingere o tirare. Guarnizioni intumescenti sul telaio.

FONO ISOLAMENTO 47 db

Fire resistant door with extruded aluminum frame to fit in the masonry or in plasterboard 125 mm thick to be sure of EI 60 fire resistance. 103 mm thick leaf which can be flush to the wall in pull or push side. Intumescent gasket on the frame.

SOUND INSULATION 47 db

MURATURA - MASONRY

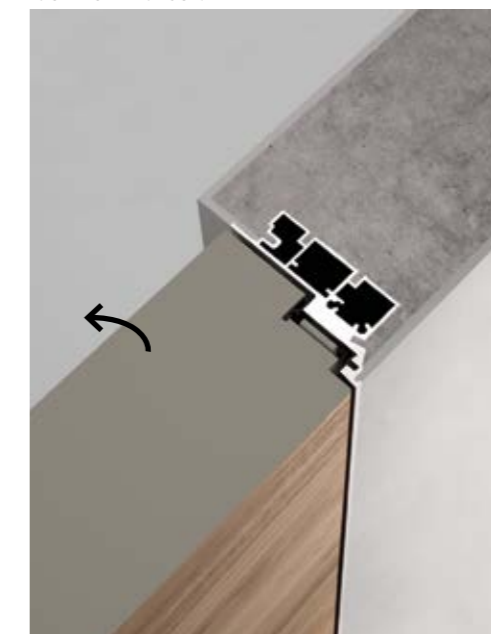

Vedi catalogo Re di Garofoli
per approfondimenti
See Garofoli Re catalogue
for details



FILOMURO BLINDATA

FILOMURO SECURITY

Nel settore delle porte blindate, Garofoli sapientemente accorda **sicurezza e armonia estetica**. Le soluzioni proposte sono identiche alle altre porte e s'integrano perfettamente alla boiserie, al parquet, agli armadi a muro, consentendo la massima libertà stilistica sia in esterno sia negli ambienti interni. La cura dei dettagli, l'accurata selezione dei materiali e una tecnologia esclusiva esaltano la bellezza di soluzioni sempre belle e sicure.

*Garofoli armoured doors skilfully achieve both **security and aesthetic harmony**. The solutions proposed are identical to the other doors, integrating perfectly with boiserries, parquet and closet entrances, and allowing maximum stylistic freedom both indoors and outdoors. The attention to detail, careful selection of materials and exclusive technology enhance the beauty of solutions that are always secure and elegant.*



Finitura Rovere Teak
teak oak finish

FILOMURO REGINA

FILOMURO REGINA

Il portone blindato Regina può avere la complanarità tra anta e muro, e può essere coordinato con tutte le finiture disponibili nelle collezioni del Gruppo Garofoli (pannelli, mostrine, imbotte). Disponibile in versione Filomuro o con certificazione EI30. Regina può essere coordinata con tutte le finiture disponibili nelle collezioni del Gruppo Garofoli (pannelli, mostrine, imbotte). Regina è certificata in classe 3. Abbattimento acustico 40db.

MURATURA - MASONRY



The Regina security door is available with flush fit between door and wall, and can be coordinated with all the finishes available in the Garofoli Group collections (panels, jamb, additional frames). Regina is available in the Filomuro version and with the EI30 certification (not for the Filomuro version) as Class 3, burglar resistance. Acoustic abatement is 40db.



Vedi catalogo Lady e Regina di Garofoli per approfondimenti
See Garofoli Lady and Regina catalogue for details



SOLUZIONI COMPLEMENTARI

COMPLEMENTARY SOLUTIONS

La cura del dettaglio e l'attenzione alle moderne esigenze dell'Interior design hanno consentito la realizzazione di **complementi d'arredo esclusivi**, ideali per la creazione di **ambienti coordinati**, dallo stile rigoroso ed essenziale. Battiscopa, ante armadio, parquet, boiserie, vani d'ispezione e tutto quanto può esaltare l'eleganza di un ambiente esclusivo.

*Garofoli offers an **exclusive collection** of furnishing accessories, developed with attention to detail and the needs of modern interior design. These are ideal for the creation of **coordinated environments**, with a minimal, essential style: skirting, wardrobe doors, parquet, boiserie, inspection panels and all the other furnishings needed to enhance the elegance of an exclusive environment.*



Finitura tinteggiabile, effetto cemento
cement plaster finish

ARMADI FILOMURO MIRIA

MIRIA FILOMURO WARDROBES

Riporre, organizzare, contenere... arredando. A questa specifica esigenza di funzionalità e stile risponde Miria, una collezione di pannelli che consentono di **creare armadi a muro**, cabine armadio su misura d'infinita tipologie e finiture.

MURATURA - MASONRY



Store, contain and organise... but still achieve fine design. Miria responds to a wide range of functional and stylistic requirements, offering a selection of panels for creation of custom-built closets, **wall-mounted wardrobes**, and storage spaces of infinite types and finishes.



Vedi catalogo Miria di Gidea
per approfondimenti
See Miria by Gidea catalogue
for details



Finitura tinteggiabile, effetto cemento
cement plaster finish



Finitura tinteggiabile
Paintable finish

BATTISCOPIA FILOMURO

FILOMURO SKIRTING BOARD

Questa nuova tipologia d'installazione, realizzabile grazie ad un profilo in alluminio, disponibile per muratura e per cartongesso, consente d'**incassare nella parete il battiscopa liscio, coordinabile** con il parquet e gli scalini, per spazi in totale armonia estetica. L'assoluta planarità assicura inoltre la massima igiene e facilità di pulizia.

MURATURA - MASONRY



*For spaces achieving total aesthetic harmony, this new type of installation permits **embedding the skirting in the wall and coordination** with the parquet or steps: a result made possible by an aluminium profile, available for both masonry and plasterboard. The absolute flatness also ensures ease of cleaning and maximum hygiene.*



Vedi catalogo Battiscopa Filomuro di Garofoli per approfondimenti
See Garofoli Filomuro Skirting Catalogue for details

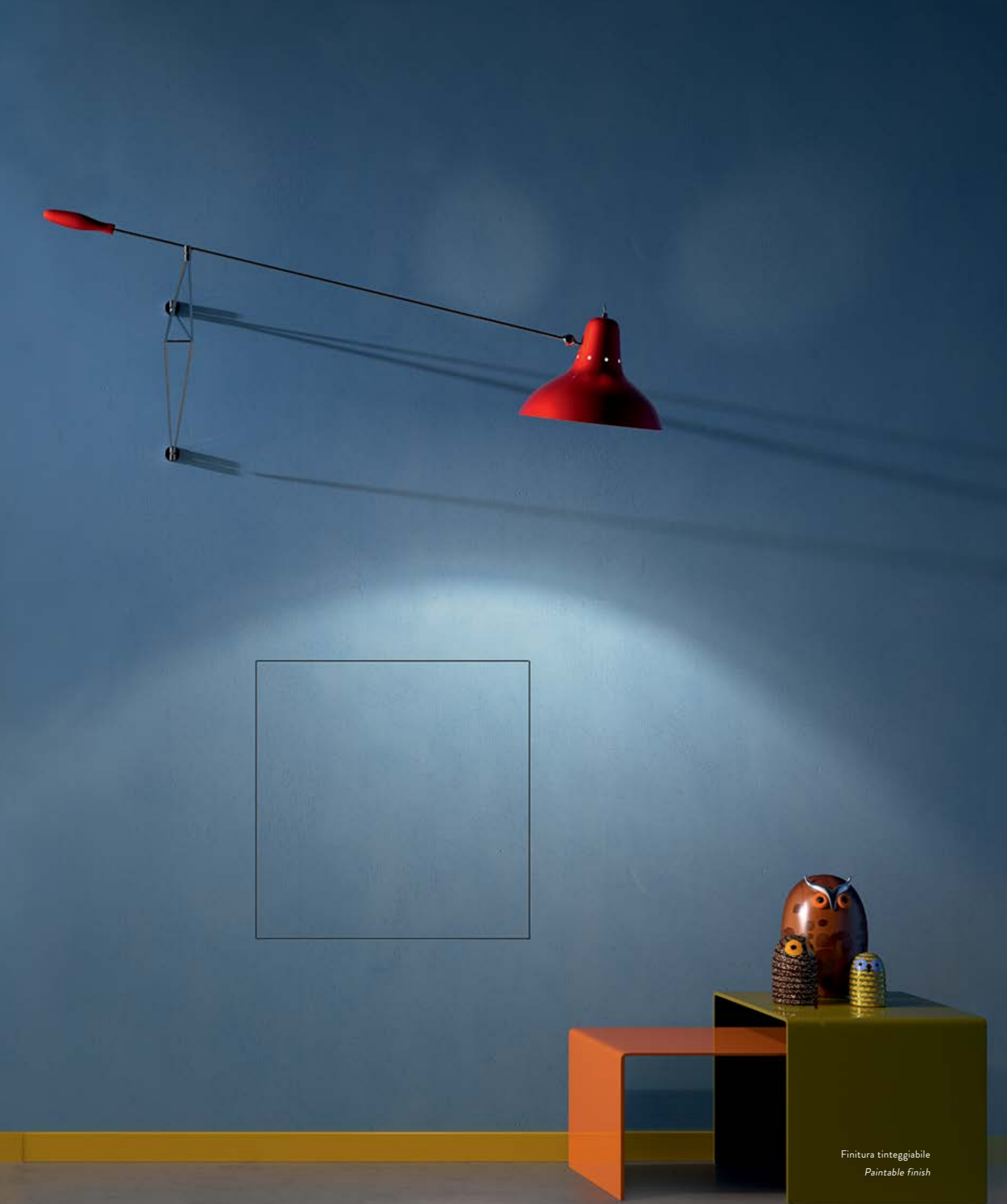

Finitura tinteggiabile
Paintable finish

FILOMURO CHIUDI CHIUDI

FILOMURO CHIUDI CHIUDI

Per abitazioni, spazi commerciali o pubblici, per chi ha **necessità progettuali specifiche** in termini di sicurezza, rispetto delle norme e funzionalità, una soluzione Garofoli Chiudi Chiudi coniuga sapientemente funzionalità ed estetica, favorendo la creazione di ambienti in cui vivere e lavorare in assoluto comfort e sicurezza.

MURATURA - MASONRY



*Garofoli Chiudi Chiudi cleverly combines functionality and aesthetics, **enabling design solutions** that meet safety, regulatory and functional requirements for homes, commercial and public spaces. Chiudi Chiudi allows for the creation of living and work spaces that feature absolute comfort and safety.*



FINITURE FILOMURO

FILOMURO FINISHES

Le porte Filomuro sono disponibili in legno, in finitura laccato con rivestimento coordinato alla boiserie o tinteggiabile, in tutte le dimensioni, forme, colori e materiali. Le colorazioni dei telai e delle finiture le potete trovare sul listino Gaorfoli e Gidea. Per consultare tutte le opzioni possibili.

Filomuro doors are available in wood, in lacquered finishes, with cladding coordinated with the boiserie or paintable, and in all dimensions, forms, colours and materials. The Gaorfoli and Gidea catalogues show all the finish and frame colours, for consultation of all possible options.

RIVESTIMENTO BOISERIE
BOISERIE COVERINGS



VETRI
GLASS



INTONACABILI O VERNICIABILI
PAINTABLE OR PLASTER-READY FINISH



LEGNI
WOOD



LACCATI (OPACHI/LUCIDI)
LACQUERS (MATT/GLOSS)



RIVESTIBILI
COVERABLE



LAMINATI
LAMINATES



FINITURE

FINISHES

In legno, in vetro, laccate in tutte le finiture della tavolozza RAL, opache e lucide, tinteggiabili oppure intonacate o rivestite con carta da parati. Le porte Filomuro Garofoli possono vestirsi di **qualsiasi materiale** per offrire la massima possibilità di **personalizzazione** e per adeguarsi a qualsiasi progetto.

*Wood, glass, lacquered in every finish of the RAL palette, matt or glossy, paintable, plastered or covered with wallpaper. Filomuro Garofoli doors can be dressed in **any material**, ensuring **maximum customisation** and adaptation to any project.*



TIPOLOGIE DI MANIGLIE

HANDLE TYPES

Maniglie dal design classico e maniglie dallo stile essenziale e minimalista, proposte di tendenza e soluzioni in diversi materiali e colori: **ogni porta ha la sua maniglia**. Frutto di ricerca e innovazione costanti le maniglie della gamma assicurano la massima funzionalità e sicurezza nel tempo.

Each door has its own handle: classic designs, minimalist and essential styles, new innovations and solutions in different materials. Handles in the Garofoli range ensure maximum safety and long-term functionality, the result of constant research and development.

PLAYA



SIRIO



AREA 51



BOLT



MANIGLIE CONSIGLIATE

SUGGESTED HANDLES

Lo stile è nel dettaglio, una porta perfetta si deve aprire e chiudere perfettamente. Per tutte le tipologie di porta Garofoli propone maniglie in sintonia con lo stile progettuale, ma sempre dotate di una sofisticata struttura meccanica che assicura le più **elevate performance tecniche**.

The style is in the details.
A perfect door opens and closes perfectly. All the types of Garofoli doors are offered with handles in keeping with their style, and always incorporating sophisticated mechanisms ensuring the **highest level of technical performance**.

LINK



LUCE



AMBRA



ANTIPANICO SLASH



POMOLO SQUADRA



TOUCH ME



PAMAR



MANIGLIONE 25



MANIGLIONE AREA 51



MANIGLIONE SIRIO



MANIGLIE CONSIGLIATE

SUGGESTED HANDLES

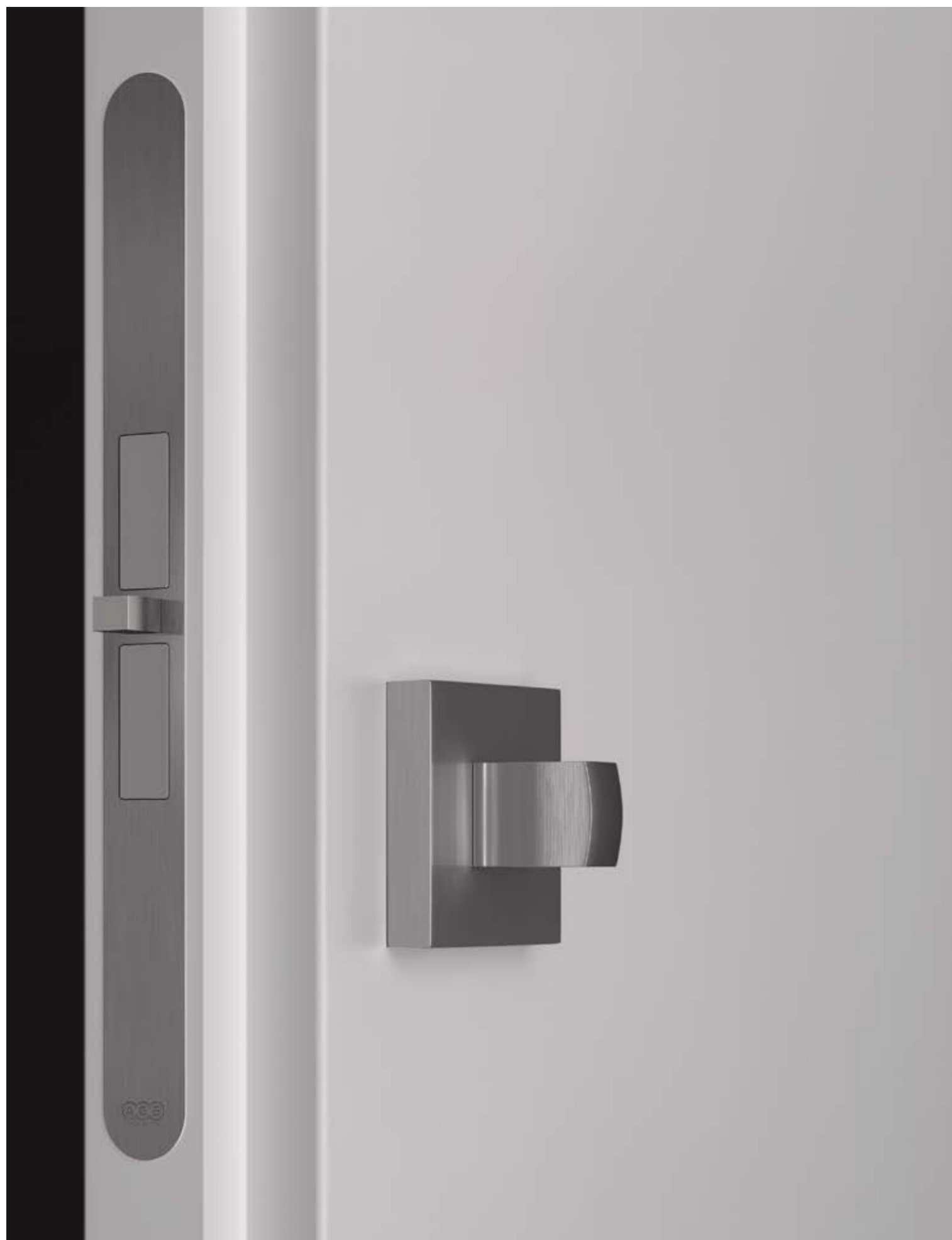

ACCESSORI

ACCESSORIES



SERRATURA SILENTE MAGNETICA CON NOTTOLINO
MAGNETIC SILENT LOCK WITH LATCH

1



SERRATURA SILENTE MAGNETICA
MAGNETIC SILENT LOCK

2



SERRATURA MAGNETICA PER FILOMURO
MAGNETIC LOCK FOR FILOMURO

3



SERRATURA MAGNETICA SENZA FORO CHIAVE PER FILOMURO
MAGNETIC LOCK WITH KEYHOLE FOR FILOMURO

4



SERRATURA MAGNETICA TOILET PER FILOMURO
BATHROOM MAGNETIC LOCK FOR FILOMURO

5



SERRATURE DISPONIBILI

LOCKS AVAILABLE

1. Bronzo, Ottone lucido, Cromo lucido, Cromo satinato
Bronze, Polished brass, Polished chrome, Satin chrome
2. Bronzo, Ottone lucido, Cromo lucido, Cromo satinato
Bronze, Polished brass, Polished chrome, Satin chrome
3. Bronzo, Ottone lucido, Cromo lucido, Cromo satinato
Bronze, Polished brass, Polished chrome, Satin chrome
4. Cromo lucido, Cromo satinato
Polished chrome, Satin chrome
5. Bronzo, Ottone lucido, Cromo lucido, Cromo satinato
Bronze, Polished brass, Polished chrome, Satin chrome

CONTROPIASTRINO ELETTRICO - MAGNETICO
ELECTRO-MAGNETIC STRIKE PLATE



SERRATURA MAGNETICA YALE PER FILOMURO
YALE MAGNETIC LOCK FOR FILOMURO

7



SERRATURA TRIPLICE CHIUSURA PER FILOMURO
TRIPLE CLOSURE LOCK FOR FILOMURO

8



CERNIERA A SCOMPARSA CON CHIUDIPIORTA
CONCEALED HINGE WITH DOOR-CLOSING DEVICE



LAMA TAGLIAFREDDO
DRAUGHT EXCLUDER

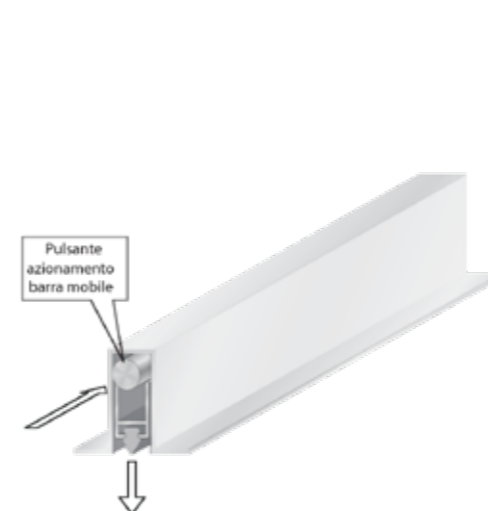

GRIGLIA PER AERAZIONE
VENTILATION GRILLE IN METAL

9

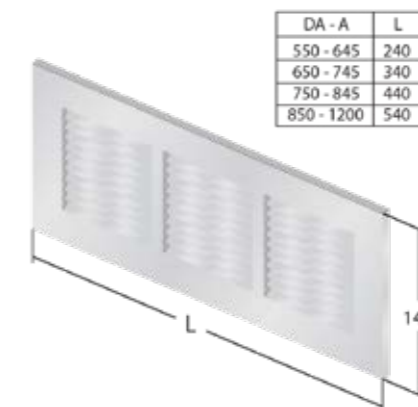

CHIUDIPIORTA A SCOMPARSA INCASSATO A SLITTA
CONCEALED DOOR CLOSER WITH SLIDE



CHIUDIPIORTA A MOLLA
SPRING DOOR CLOSER

10



ACCESSORI DISPONIBILI

ACCESSORIES AVAILABLE

- 7_ Bronzo, Ottone lucido, Cromo lucido, Cromo satinato
Bronze, Polished brass, Polished chrome, Satin chrome
- 8_ Ottone lucido, Cromo lucido
Polished brass, Polished chrome
- 9_ Ottone lucido, Cromo lucido, Cromo satinato
Polished brass, Polished chrome, Satin chrome
- 10_ Ottone lucido, Cromo lucido, Cromo satinato
Polished brass, Polished chrome, Satin chrome







SPECIFICHE TECNICHE

TECHNICAL DETAILS

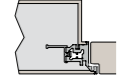
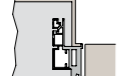
TELAI E ANTE ABBINABILI

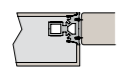
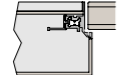
COMBINABLE FRAMES AND DOORS

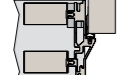
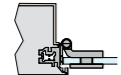
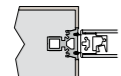
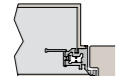
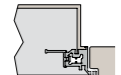
PORTE FILOMURO FILOMURO DOORS	TELAI FRAMES	ANTE - DOORS							
		Grezza Grezza	1L	Orizzonte LT	Orizzonte 1F Gidea 1F	Orizzonte 2F Gidea 2F	Orizzonte 3F Gidea 3F	Orizzonte 5F Gidea 5F	BiGlass
STANDARD	 Telaio 45 mm	●	●	●	●	●	●	●	●
	 Telaio 60 Battente	●	●	●	●	●	●	●	
	 Telaio 103 mm	●	●	●	●	●	●	●	●
INNOVATIVE	 Telaio Biverso	●	●	●	●	●	●	●	
	 Telaio per boiserie	●	●	●	●	●	●	●	●
	 Bilico	●	●	●	●	●	●	●	
	 Bilato	●		●					
	 G-like								
	 Telaio per 1 TV								
	 Telaio Total								●
METACRILATO	 Telaio 45 mm		●		●	●	●	●	
LAMINATO	 Telaio 45 mm		●		●	●	●	●	

ANTE - DOORS										
BiPlan	Panvi	7PA Biplus	7PAL legno	Boise	Predia LTM	Vitra 1V2008 Gidea 1V2007	Rubia	Minia	Varia	1TV
●	●	●	●	●	●	●	●			
●	●	●	●	●	●	●	●			
●	●	●	●	●						
								●	●	
										●
●	●	●	●							
						●				

TIPOLOGIE PORTE

DOOR TYPES

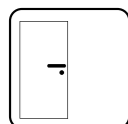

PORTA SINGOLA
SINGLE DOOR

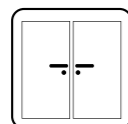

PORTA DOPPIA
DOUBLE DOOR

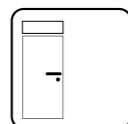

**PORTA SINGOLA
CON SOPRALUCE
CECO O VETRO**
SINGLE DOOR WITH
BLIND OR GLASS
TRANSOM

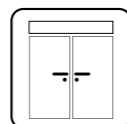

**PORTA DOPPIA
CON SOPRALUCE
CECO O VETRO**
DOUBLE DOOR WITH
BLIND OR GLASS
TRANSOM

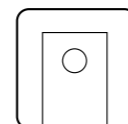

MAX 0,25 MQ
OBLÓ ROTONDO
ROUND PORTHOLE

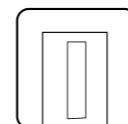

MAX 0,25 MQ
**OBLÓ
RETTANGOLARE**
RECTANGULAR
PORTHOLE

RESISTENZA AL FUOCO

FIRE RESISTANCE



30 min
FILOMURO REI 30



60 min
FILOMURO REI 60



120 min
FILOMURO REI 120

PROVA FUMI

SMOKE TEST



CALDI
HOT



FREDDI
COLD

ISOLAMENTO ACUSTICO

SOUND INSULATION



28 db
ANTA 60 MM
60 MM DOOR

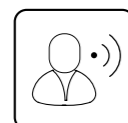

35 db
ANTA 45 MM
45 MM DOOR



38 db
ANTA 45 MM
45 MM DOOR



38 db
ANTA 60 MM
60 MM DOOR

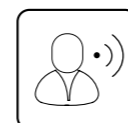

40 db
ANTA 45 MM
45 MM DOOR

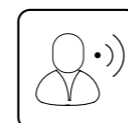

42 db
ANTA 60 MM
60 MM DOOR

PORTE CLIMATICHE

INSULATING DOOR



PORTA KLIMA
ANTA 60 MM
60 MM DOOR

CLASSE EFFRAZIONE

CLASS BURGLAR



CLASS 3
BLINDATA REGINA
BLINDATA REGINA

TIPOLOGIE DI PORTE

DOOR TYPES

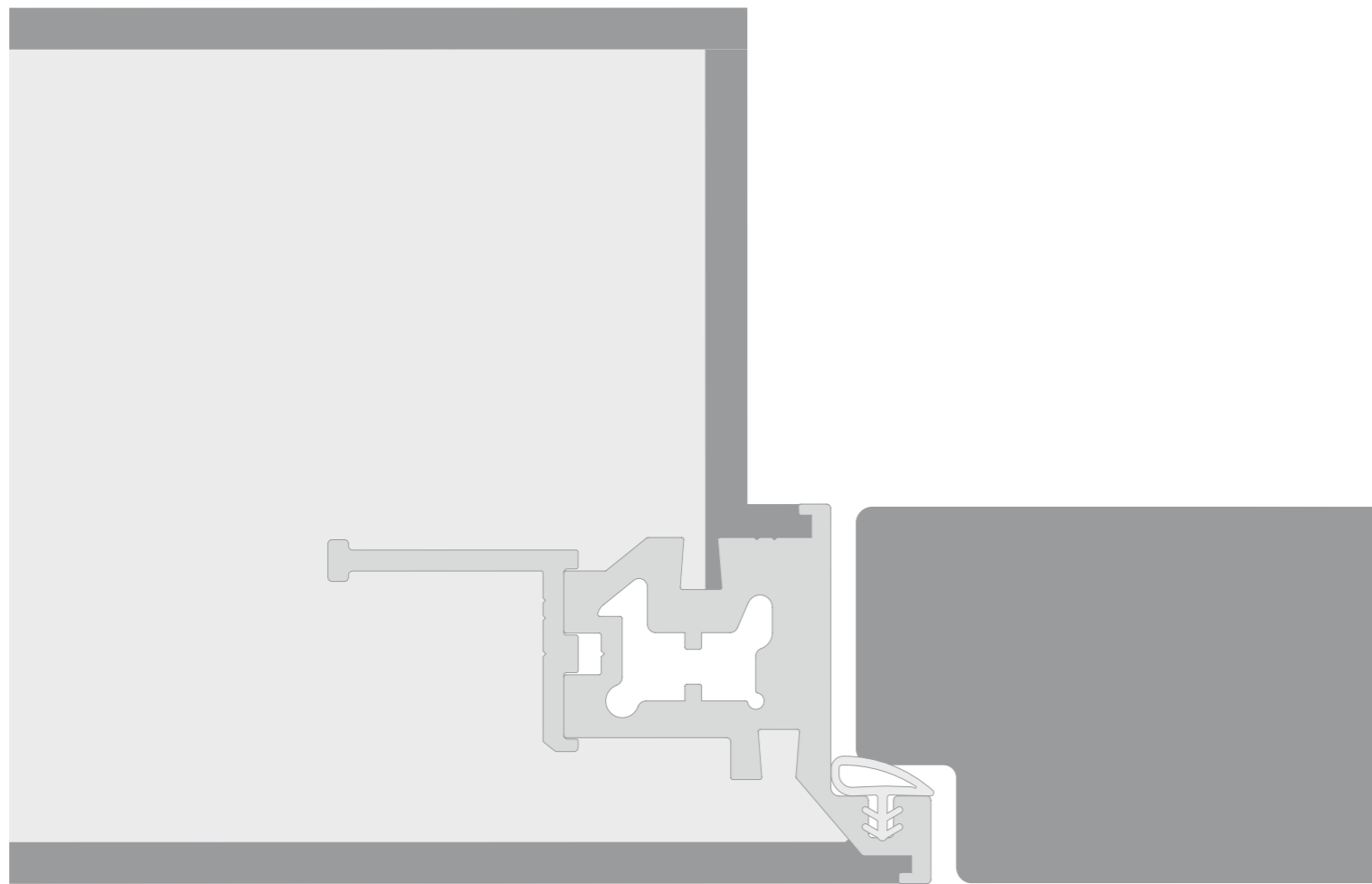

SEZIONI
CROSS-SECTIONS

SOLUZIONI TRADIZIONALI

TRADITIONAL SOLUTIONS

SEZIONI

FILOMURO 45 MM

FILOMURO 45 MM



FILOMURO DOPPIA

FILOMURO DOUBLE

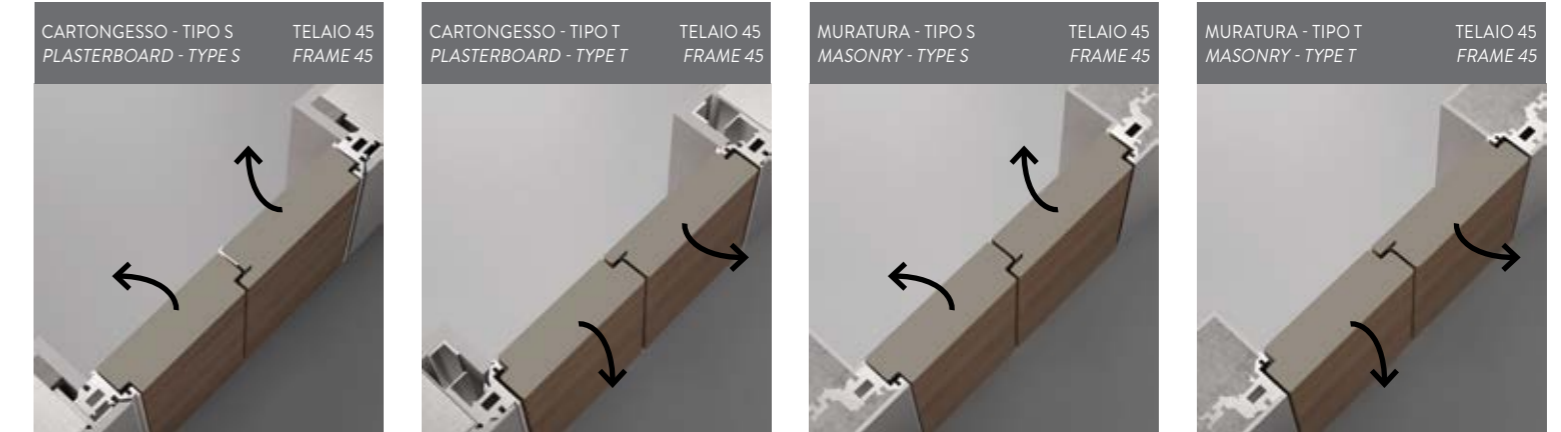

FILOMURO 60 MM

FILOMURO 60 MM

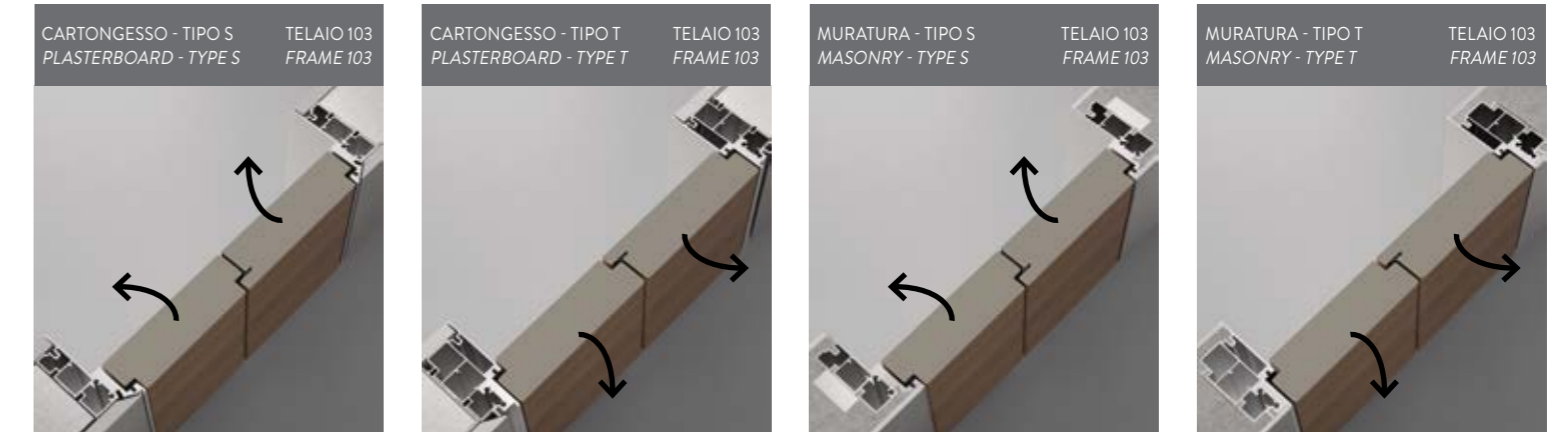
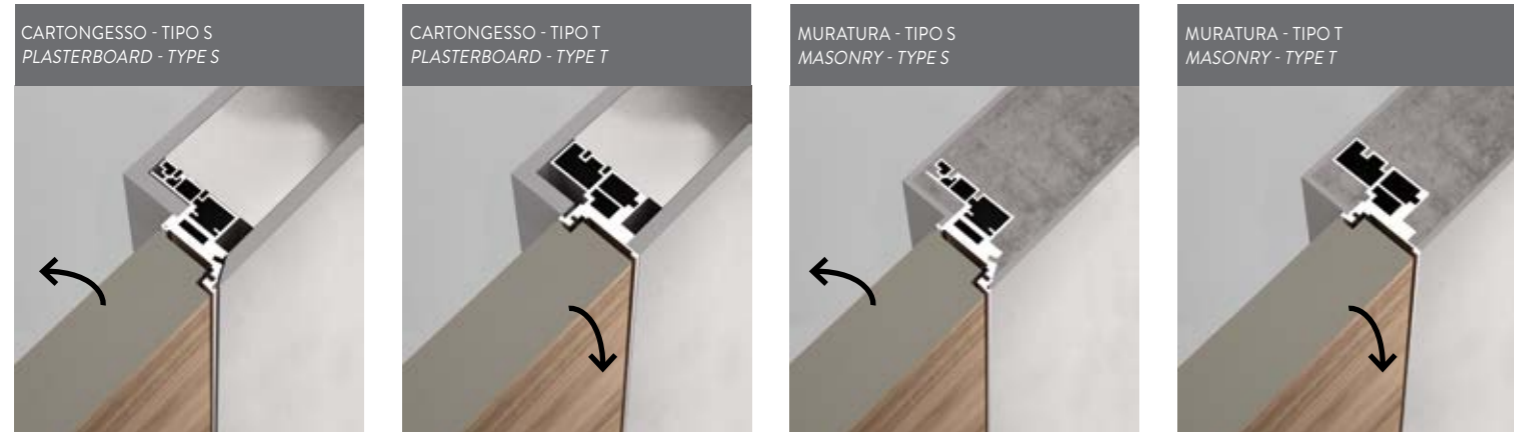

FILOMURO 103 MM

FILOMURO 103 MM

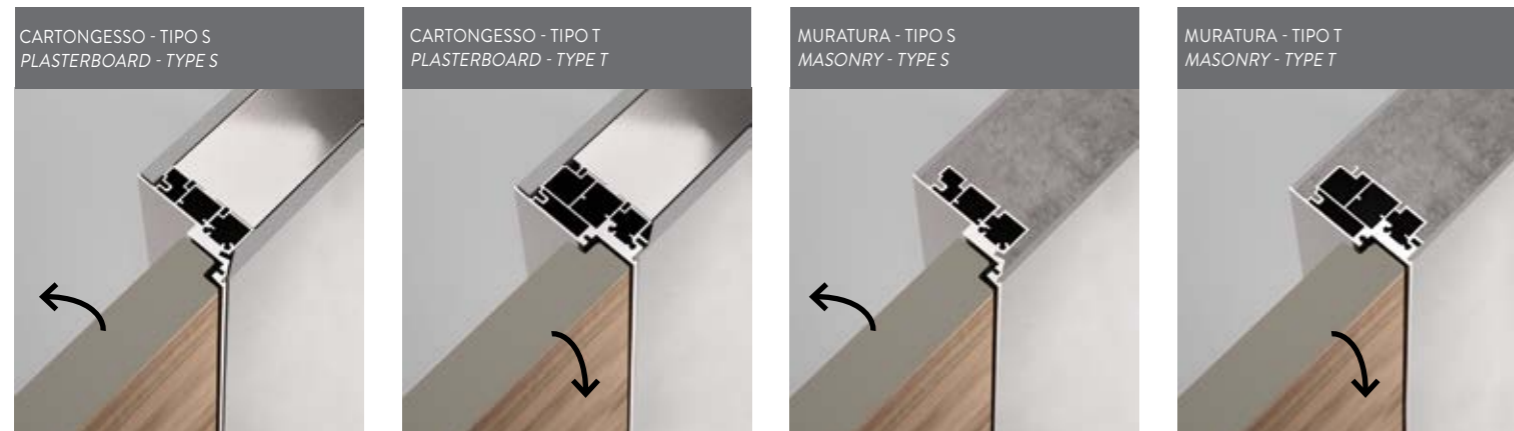

SOLUZIONI INNOVATIVE

INNOVATIVE SOLUTIONS

SEZIONI

FILOMURO BIVERSO
FILOMURO BIVERSO

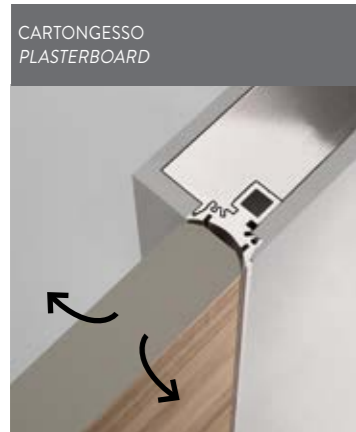

FILOMURO BILATO
FILOMURO BILATO



FILOMURO BILICO
FILOMURO BILICO

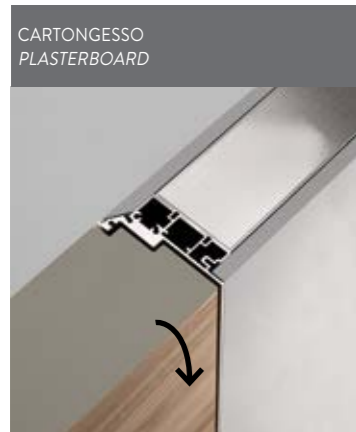

FILOMURO BOISE
FILOMURO BOISE

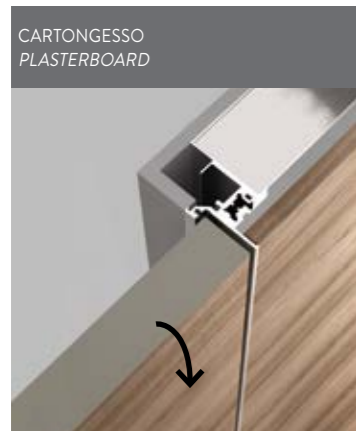

FILOMURO BIPLAN
FILOMURO BIPLAN



FILOMURO PANVI
FILOMURO PANVI

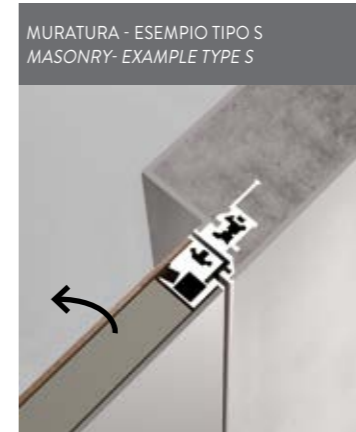

FILOMURO BIGLASS
FILOMURO BIGLASS

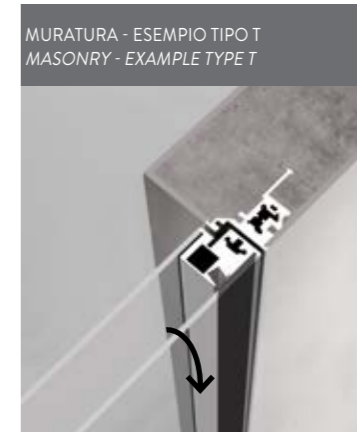

FILOMURO BIGLASS A SPECCHIO
FILOMURO BIGLASS MIRROR



FILOMURO TOTAL BIGLASS
FILOMURO TOTAL BIGLASS



FILOMURO RUBIA
FILOMURO RUBIA



SOLUZIONI INNOVATIVE

INNOVATIVE SOLUTIONS

FILOMURO G-LIKE FILOMURO G-LIKE

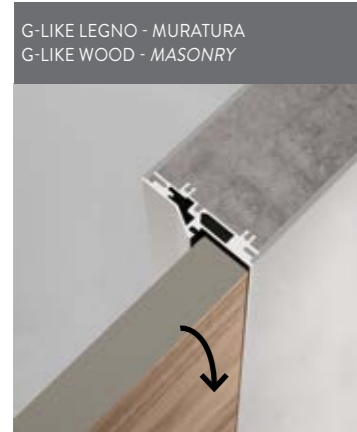

G-LIKE PROFILO BLADE G-LIKE PROFILO BLADE



FILOMURO 1TV CON CERNIERA PIVOTANTE 1TV WITH PIVOTING HINGE

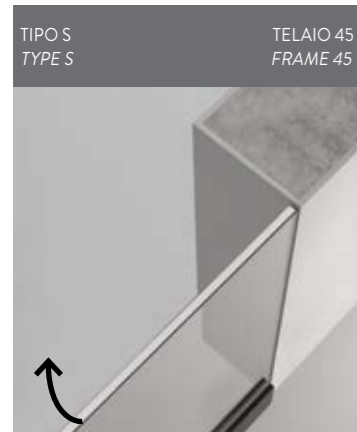

FILOMURO 1TV FILOMURO 1TV

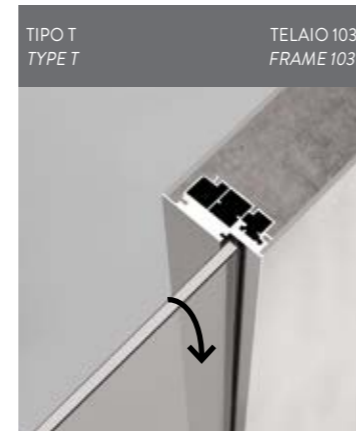
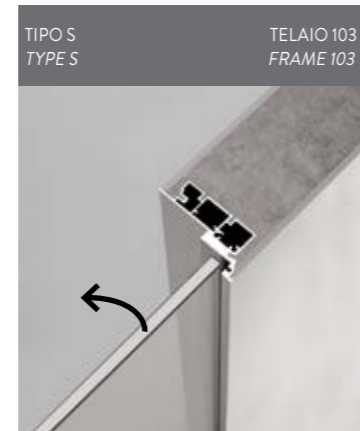

SOLUZIONI REI

FILOMURO REI SOLUTIONS

FILOMURO REI 30* FILOMURO REI 30*



FILOMURO REI 60* FILOMURO REI 60*



FILOMURO REI 120* FILOMURO REI 120*

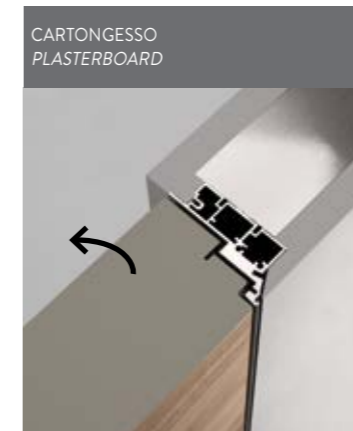

Vedi catalogo Rei di Garofoli
per approfondimenti
See Garofoli Rei catalogue
for details

SOLUZIONI BLINDATA

FILOMURO BLINDATA SOLUTIONS

SEZIONI

FILOMURO REGINA** FILOMURO REGINA**



** Vedi catalogo Lady e Regina di Garofoli per approfondimenti
See Garofoli Lady and Regina catalogue for details

BATTISCOPIA FILOMURO**** FILOMURO SKIRTING BOARD****

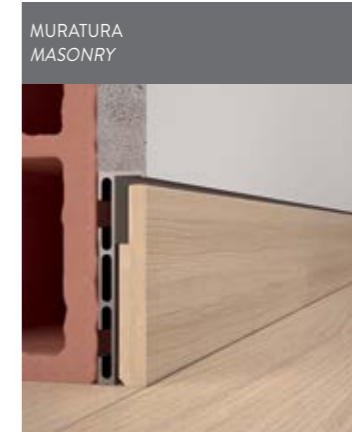

FILOMURO CHIUDI CHIUDI FILOMURO CHIUDI CHIUDI

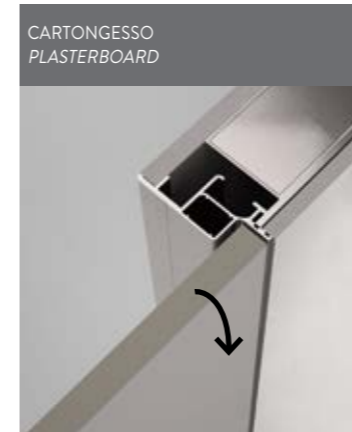

SOLUZIONI COMPLEMENTARI

COMPLEMENTARY SOLUTIONS

ARMADI FILOMURO MIRIA*** MIRIA FILOMURO WARDROBES***

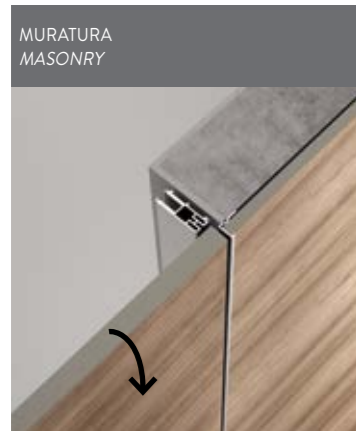

*** Vedi catalogo Miria di Gidea per approfondimenti
See Miria by Gidea catalogue for details



**** Vedi catalogo Battiscopa Filomuro di Garofoli per approfondimenti
See Garofoli Filomuro Skirting Catalogue for details

Le finiture in legno non sono con anta Filomuro ma Plania (con profilo in metallo visibile).
Finishes in wood (with metal profile visible) are available with Plania, but not with Filomuro doors.

CERTIFICAZIONI | CERTIFICATIONS | CERTIFICATIONS | CERTIFICACIONES | ZERTIFIZIERUNGEN | СЕРТИФИКА

Il Gruppo Garofoli ha sempre mirato alla qualità, promuovendo lo sviluppo sostenibile delle proprie attività e perseguendo una decisa politica ambientale. Una filosofia che ha portato al raggiungimento di importanti traguardi.

Garofoli - Gidea › **ISO 9001 Sistema di gestione della qualità.**

Garofoli › **ISO 14001 Sistema di gestione ambientale.**

Garofoli › **PEFC/CoC Program for endorsement of forest certification schemes**, lo schema più diffuso e famoso al mondo per la gestione sostenibile delle foreste.

Garofoli › **ISO 45001 Sistema di gestione della sicurezza e salute dei lavoratori**

Garofoli › **Catena di custodia FSC <https://it.fsc.org>**

Le **Groupe Garofoli** a toujours recherché la qualité, promouvant le développement durable de ses activités et poursuivant une politique environnementale claire. Une philosophie qui a permis d'atteindre des objectifs majeurs.

Garofoli - Gidea › **ISO 9001** Système de management de la qualité.

Garofoli › **ISO 14001** Système de management environnemental.

Garofoli › **PEFC/CoC** Program for endorsement of forest certification schemes, le système de certification le plus répandu et connu au monde pour la gestion durable des forêts.

Garofoli › **ISO 45001** Système de gestion de la santé et de la sécurité au travail.

Garofoli › Chaîne de traçabilité **FSC <https://fr.fsc.org>**

Die **Gruppe Garofoli** setzt seit jeher auf Qualität, und in diesem Sinn auf eine nachhaltige, umweltverträgliche Firmenpolitik. Eine Unternehmensphilosophie, die sich unter allen Aspekten als zielführend und gewinnbringend erwiesen hat.

Garofoli - Gidea › **ISO 9001** Qualitätsmanagementsystem.

Garofoli › **ISO 14001** Umweltmanagementsystem.

Garofoli › **PEFC/CoC** Program for endorsement of forest certification schemes. Das bekannteste und weltweit am meisten genutzte Konzept zur nachhaltigen Bewirtschaftung und Nutzung der Wälder.

Garofoli › **ISO 45001** Arbeitsschutzmanagement-System.

Garofoli › Aufbewahrungskette **FSC <https://fr.fsc.org>**

The **Garofoli Group** has always aimed at quality, promoting the sustainable development of its business activities and pursuing a strong environmental policy. A philosophy which has resulted in the attainment of important goals.

Garofoli - Gidea › **ISO 9001** Quality management system.

Garofoli › **ISO 14001** Environmental management system.

Garofoli › **PEFC/CoC** Certification program for endorsement of forest certification schemes, the most widespread and renowned scheme in the world for sustainable forest management.

Garofoli › **ISO 45001** Certification management system for occupational health and safety.

Garofoli › Chain of custody **FSC <https://en.fsc.org>**

El **Grupo Garofoli** persigue desde siempre la calidad, promoviendo el desarrollo sostenible de sus actividades y adoptando una específica política ecológica. Esta filosofía lo ha llevado a alcanzar importantes objetivos.

Garofoli - Gidea › **ISO 9001** Sistema de gestión de la calidad.

Garofoli › **ISO 14001** Sistema de gestión medioambiental.

Garofoli › **PEFC/CoC** Program for endorsement of forest certification schemes. El esquema más difundido y famoso en todo el mundo por lo que concierne la gestión forestal sostenible.

Garofoli › **ISO 45001** sistema de gestión para la seguridad y salud laboral.

Garofoli › Cadena de custodia **FSC <https://es.fsc.org>**

Группа Garofoli всегда заботилась о качестве, способствовала экологически рациональному развитию своего бизнеса, придерживаясь твердой стратегии, связанной с защитой окружающей среды. Такой подход позволил группе добиться важных результатов.

Garofoli - Gidea › **ISO 9001** Система менеджмента качества.

Garofoli › **ISO 14001** Система экологического менеджмента.

Garofoli › **PEFC/CoC** Program for endorsement of forest certification schemes. Самая широко распространенная и известная программа в мире по экологически рациональному управлению лесными богатствами.

Garofoli › **ISO 45001** Система менеджмента техники безопасности и охраны здоровья на рабочем месте.

Garofoli › Цепочка опеки **FSC <https://es.fsc.org>**



Tutti i modelli possono subire in qualsiasi momento senza preavviso qualche lieve variazione nelle sezioni, nella struttura, nel disegno e nel colore; pertanto, qualora a nostro insindacabile giudizio resti immutata l'estetica complessiva e la solidità della porta, il cliente non potrà recedere dal contratto, né avrà diritto a sconti o abbuoni particolari. Tutte le essenze, i colori e le trasparenze dei vetri, particolari dei modelli e modelli delle porte illustrati nel presente catalogo sono da ritenersi indicativi e possono subire modifiche.

All models may be subject to slight variations in section, structure, design and colour at any time, without advance notice; therefore, if the overall appearance and solidity of the door remains unchanged in our unquestionable judgement, the client may not withdraw from the contract, nor be entitled to special discounts or rebates. All of the woods, coloured and transparent glass, door models and details of the models illustrated in this catalogue are merely indicative and may be subject to modification.

Tous les modèles peuvent subir, à tout moment et sans préavis, de légères variations dans les sections, la structure, le design et la couleur; par conséquent, lorsque l'esthétique globale et la solidité de la porte restent telles qu'elles selon notre jugement sans appel, le client ne pourra annuler le contrat ni aura le droit à réductions ou remises particulières. Tous les essences, teintes et transparences des vitres, détails des modèles des portes illustrés dans ce catalogue sont à considérer comme indicatifs et peuvent être sujets à modifications.

Todos los modelos pueden sufrir, en cualquier momento y sin previo aviso, leves modificaciones en las secciones, la estructura, el motivo o el color; mientras estas modificaciones, a juicio inapelable del fabricante, no alteren la estética general ni la solidez de la puerta, el cliente no podrá rescindir el contrato ni tendrá derecho a descuentos o bonificaciones de ningún tipo. Todas las maderas, los colores y las transparencias de los cristales, el diseño de las puertas y los respectivos detalles ilustrados en este catálogo deben considerarse indicativos y pueden sufrir modificaciones.

Der Hersteller behält sich das Recht vor, an allen Modellen jederzeit ohne Vorankündigung geringfügige mass-, struktur-, design- und farbänderungen vorzunehmen; sofern nach dem unanfechtbaren Ermessen des Herstellers dadurch weder die Gesamtoptik noch die Robustheit der Tür beeinträchtigt werden, hat der Kunde kein Recht auf Stornierung des Auftrags und/oder Preisnachlässe und/oder Gutschriften jeglicher Art. Alle Hölzer, die Farben und die Transparenzen der Gläser, Details der Modelle und Modelle der in diesem Katalog abgebildeten Türen haben reinen Beispielcharakter, Abweichungen sind daher möglich.

Все модели могут претерпеть в любой момент и без предупреждения небольшие изменения сечений, конструкции, дизайна и цвета. Поэтому, если по нашему неоспоримому мнению общий вид и прочность двери не меняются, клиент не имеет права расторгнуть контракт, а также требовать скидку или специальную компенсацию. Все породы древесины, цвета, степень прозрачности стекла, детали моделей и модели дверей, представленные в этом каталоге, должны считаться ориентировочными и могут претерпеть изменения.



Garofoli SpA
Via Recanatese, 37
60022 Castelfidardo
AN Italia
tel. +39 071 727171
fax +39 071 780380
info@garofoli.com
www.garofoli.com

